

DRAW WIRE SENSOR

Links to further documents for this series:
[Installation guide](#)



FX SERIES

Key-Features:

- Wear-free Hall-effect sensor element
- Ultra-compact body, Ø 38.1 mm
- Ideal for applications with very high cycle numbers
- Measurement ranges from 50 up to 375 mm
- Linearity ± 1 % of full range
- Output signal 0...10 V
- Very low weight of 35 g
- Draw wire: stainless steel, jacketed stainless steel
- Thermoplastic body

Content

Technical Data	2
Technical Drawing	2
Electrical Connection	3
Warning Notices	3
Order Code	4
Accessories	4

TECHNICAL DATA

Measurement ranges	[mm]	50 / 75 / 100 / 125 / 150 / 200 / 250 / 300 / 375
Linearity ¹⁾	[%]	±1
Repeatability ¹⁾	[%]	±0.03
Resolution ¹⁾	[%]	0.024
Sensor element		Hall-Effect sensor
Output signal	[VDC]	0...10 + 0...0.2
Output impedance max.	[Ω]	10
Output load min.	[kΩ]	100
Power supply	[VDC]	4.9...30
Excitation current max.	[mA]	30
Connection		cable output with open ends, cable output with connector at cable end with or without mating connector
Protection class		IP52
Humidity		95 %, not condensing
Reverse polarity protection		yes
Operating temperature	[°C]	-25...+75
Storage temperature	[°C]	-50...+80
Shock resistance		50 g, 0.1 ms max.
Vibration resistance		15 g, 0.1 ms max.
Life cycle		approx. 6.000.000 cycles
Extraction force	[N]	nominal 1.5
Housing		thermoplastic body
Draw wire		Nylon jacketed stainless steel Ø 0.46 mm / optional: stainless steel Ø 0.41 mm
Weight	[g]	35

¹⁾ based on the measurement range

TECHNICAL DRAWING

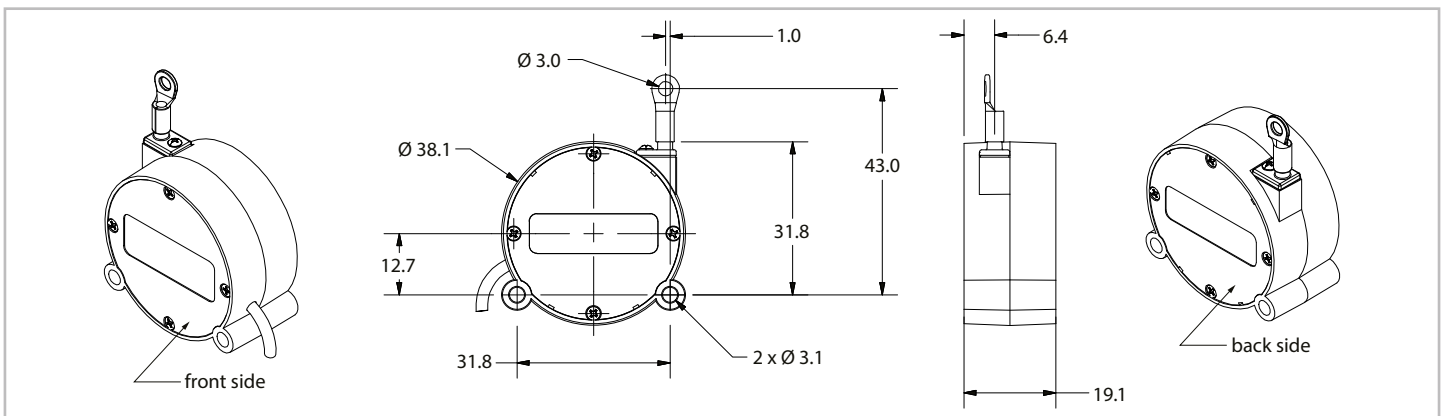

Draw wire attachment

with eye fitting

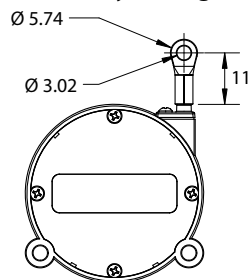

leader wire with fittings

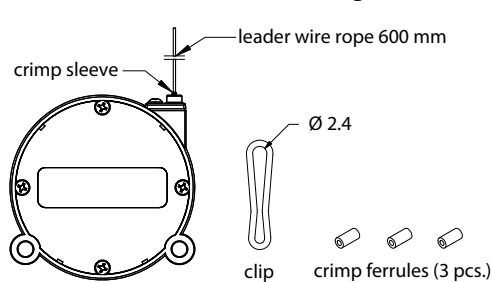

ELECTRICAL CONNECTION

Cable output

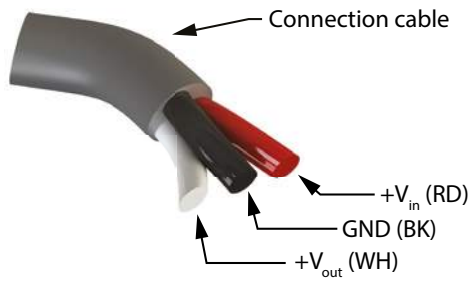

Connector output pin assignment

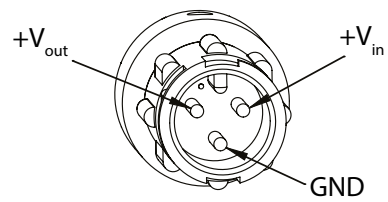

Connector output option C

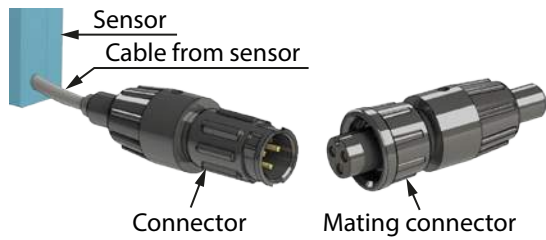

Connector output option K

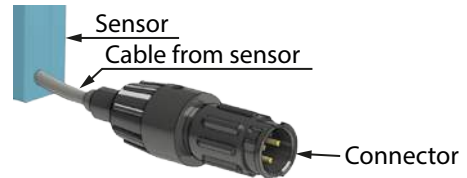

WARNING NOTICES

- Don't let the rope snap back. If the rope is retracted freely, this may lead to injuries (whiplash effect) and the device may be damaged.
- Caution when unhooking and retracting the rope into the sensor.
- Never exceed the specified measurement range when extracting the rope!
- Do not try to open the device. The stored energy of the spring drive may lead to injuries when being mishandled.
- Do not touch the rope when operating the sensor.
- Avoid guiding the rope over edges or corners. Use a deflection pulley instead.
- Do not operate the sensor if the rope is buckled or damaged. A ripping of the rope may lead to injuries or a damaging of the sensor.

ORDER CODE

FX-HM - - S - 1

Measurement range [mm]	
50	2
75	3
100	4
125	5
150	6
200	8
250	10
300	12
375	15

Draw wire	
Nylon jacketed, stainless steel, Ø 0.45 mm	N
Stainless steel, Ø 0.41 mm	S

	Connection type
N	Cable with open ends
C	Cable with connector and mating con.
K	Cable with connector without mating con.

	Cable length fixed cable
P	0.15 m
Q	0.5 m
1	1 m
2	2 m

	Draw wire attachment
1	Eye fitting
2	Leader wire rope with fitting

ACCESSORIES

Connection cable for option K

10248-1M	cable 1 m, with mating connector
10248-2M	cable 2 m, with mating connector
10248-3M	cable 3 m, with mating connector
10248-4M	cable 4 m, with mating connector
10248-5M	cable 5 m, with mating connector

Digital displays for sensors with analog output, 2 channel

WAY-AX-S	touch screen, supply: 18...30 VDC
WAY-AX-AC	touch screen, supply: 115...230 VAC

For more information and options please refer to the [WAY-AX data sheet](#).

Subject to change without prior notice.

WayCon Positionsmesstechnik GmbH

Email: info@waycon.de

Internet: www.waycon.biz

WayCon

Positionsmesstechnik

Headquarters Munich

Mehlbeerenstr. 4

82024 Taufkirchen

Tel. +49 (0)89 67 97 13-0

Fax +49 (0)89 67 97 13-250

Office Cologne

Auf der Pehle 1

50321 Brühl

Tel. +49 (0)2232 56 79 44

Fax +49 (0)2232 56 79 45