



NOTES

All the data reported in this brochure and the data sheet, like linearity, lifetime, temperature coefficient are valid for a sensor utilization as a ratiometric device with a max current across the cursor $I_c \leq 0.1 \text{ mA}$.

Do NOT use the position sensor as variable resistance!

When calibrating the transducer, be careful to set the stroke so that the output does not drop below 1% or rise above 99% of the voltage level.

MAINTENANCE

The sensors are maintenance free. It is not necessary to lubricate the moving parts.

DECLARATION OF EC-CONFORMITY

WayCon Positionsmesstechnik GmbH
Mehlbeerenstrasse 4
82024 Taufkirchen / Germany

This is to certify that the products

Classification
Series

Linear potentiometer
LMI12-SL, LMI12-SE

fulfill the current request of the following EC-directives:
EMV-directive 2004/108/CE
applied harmonized standards:
EN 61000-6-2:2005, EN 61000-6-4:2007, EN 61326-1:2006

The declaration of conformity loses its validity if the product is misused or modified without proper authorisation.

Taufkirchen, 13.03.2013

Andreas Täger
CEO

INSTALLATION GUIDE

Linear Potentiometer Series LMI12-SL, LMI12-SE

For further information please see the data sheet at www.waycon.biz/products/linear-potentiometers/

FIRST STEPS

WayCon Positionsmesstechnik GmbH would like to thank you for the trust you have placed in us and our products. This manual will make you familiar with the installation and operation of our linear potentiometers. Please read this manual carefully before initial operation!

Unpacking and checking:

Carefully lift the device out of the box by grabbing the housing. After unpacking the device, check it for any visible damage as a result of rough handling during the shipment. Check the delivery for completeness.

If necessary consult the transportation company, or contact WayCon directly for further assistance.

ELECTRICAL CONNECTION

Electrical connection LMI12-SL

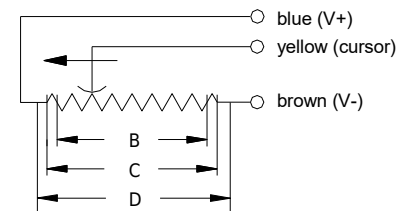

Electrical connection LMI12-SE

Signal	Colour
supply +	brown
supply -	blue
output -	blue
output +	yellow

Connect GND to the transducer's housing
(do not connect GND to the panel side)

After the installation of the sensor, the ring magnet has to be placed onto the sensor rod. In order to link the magnet to the sensor element, the magnet has to be pushed once fully to the end of the sensor rod (up to flange/cable connection).

Load Diagram LMI12-SE

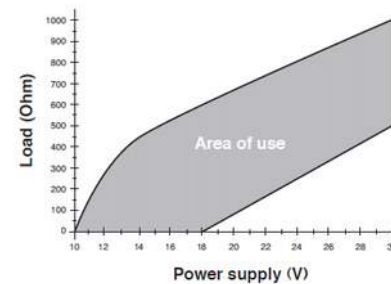

Tracking Error LMI12-SE, LMI12-SL

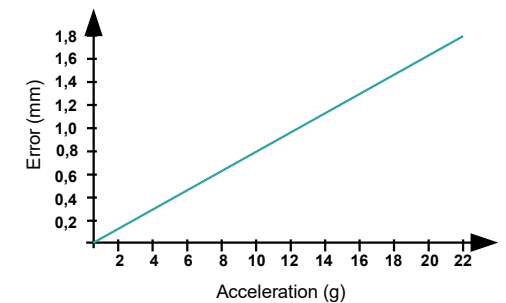

INSTALLATION GUIDE

Linear potentiometer Series LMI12-SL, LMI12-SE

For further information please see the data sheet at www.waycon.biz/products/linear-potentiometers/

TECHNICAL DRAWING

LMI12-SE with standard flange

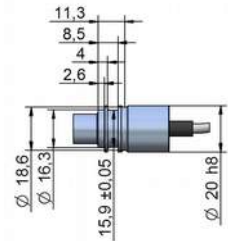

Detail drawing standard flange

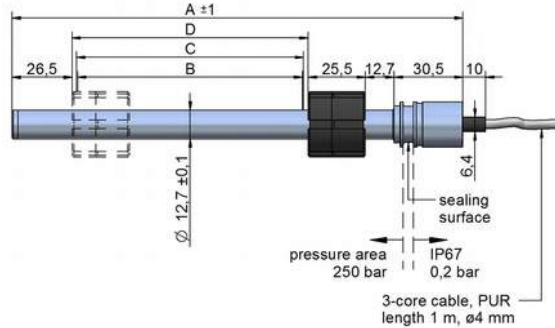

LMI12-SE-M with threaded flange

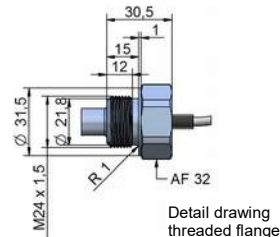
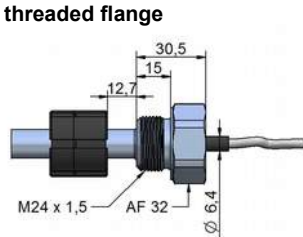

Detail drawing threaded flange

LMI12-SL with standard flange

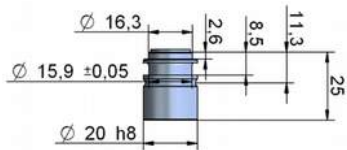

Detail drawing standard flange

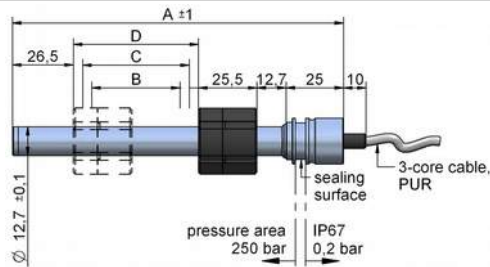

LMI12-SL-M with threaded flange

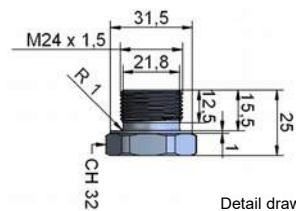
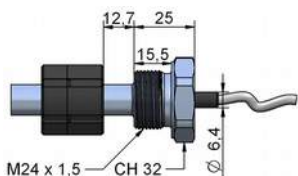

Detail drawing threaded flange

TECHNICAL DATA

Useful electrical stroke B: corresponds to the sensors measurement range

Theoretical electrical stroke C: actual length of the conductive path, that has to be longer than B, in order to get a valid electrical signal at the start and end point of the measurement range.

When calibrating the transducer, be careful to set the stroke so that the output does not drop below 1% or rise above 99% of the voltage level.

Useful electrical stroke (B) +1/0	[mm]	50	100	150	200	250	300	350	400	450	500	550	600	750	800	850	900	950	1000	
Theoretical electrical stroke (C)	[mm]	B + 1																		
Resistance (LMI12-SL)	[kOhm]	5						10						20						
Linearity	[±%]	0.35																		
Dissipation at 40°C (LMI12-SL)	[W]	1	2	3																
Max applicable voltage (LMI12-SL)	[V]	40									60									
Power supply (see Load diagram)	[V]	10 to 30																		
Mechanical stroke (D)	[mm]	B + 5																		
Case length (A) LMI12-SL	[mm]	B + 94.7																		
Case length (A) LMI12-SE	[mm]	B + 100.2																		

ACCESSORIES

Magnet PCUR010

1 piece included in delivery

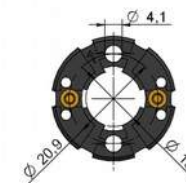
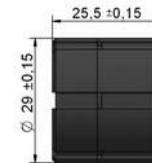

PMX-24 Signal Conditioner

- Converts potentiometer signals into analog output signals: 4...20 mA, 0...10 V, 0...5 V, ±10 V, ±5 V
- Input: potentiometer 1...20 kΩ
- Configurable output
- DIN-rail-mounting with face-side connector
- For further information please check the PMX-24 data sheet, or contact WayCon

